



Hello, I'm Simon Lakey

Lighting Control Solutions

0418 568 393

simon.lakey@lightmoves.com.au



Product update

PHILIPS

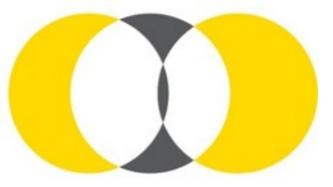
dynalite 



Introducing

ANTUMBRA

A new direction in User
Interface Design.



Superbly engineered, beautifully designed.

How to use your Antumbra finish selector

1. Choose fascia colour.
2. Choose rim colour.
3. Option to custom label – text [english, chinese, arabic] or icons.



Text example
(AntumbraButton)



Icon example
(AntumbraButton)



Icon example
(AntumbraDisplay)

AntumbraButton and AntumbraDisplay fascia finishes



AntumbraButton and AntumbraDisplay rim options



AntumbraTouch glass fascia finishes



AntumbraTouch rim options



Antumbra Online
Configurator Tool

Innovative field effects technology allows the panel to automatically detect a person's presence.

Customise panels easily with text or a range of icons.

Built-in sensors measure light level, temperature and proximity.



Users can dim lighting, monitor temperature, control the AC and blinds from one stylish panel.

Two stage installation, the hidden Communication Module can be installed and commissioned before the Application module, with no further programming.

Large button design is ideal for disability and aged care assisted living technology applications. Meets with Australian Standard: AS 1428.1-2009 14.2

Left: AntumbraButton panel with magnesium fascia
Right: AntumbraTouch panel with black fascia

A stunning 'wall wash' lighting effect is triggered when a person is detected approaching to welcome interaction.

Choose Your Preferences

- 1. Background Wall
- 2. Style
- 3. Orientation
- 4. Product Type
- 5. Fascia Colour
- 6. Rim Colour
- 7. Customized Label

Reference Details

Your Name*: Simon L.

Email Address*: simon.lakey@lightmoves.com.au

PO Number*: 160527

Company name*: Lightmoves

Project Name*: Browns Road

Panel Name*: 01 Entry

Number of Panels*: 1

Full Product PDF Button/Fascia PDF Cancel

* All fields are mandatory

Your Selection ▶

Style



Aus/NA

Orientation



Portrait

Type



Button

Colour



White

Rim



Aluminum

Label

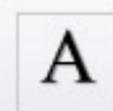

Yes

Indicator



Off

Download



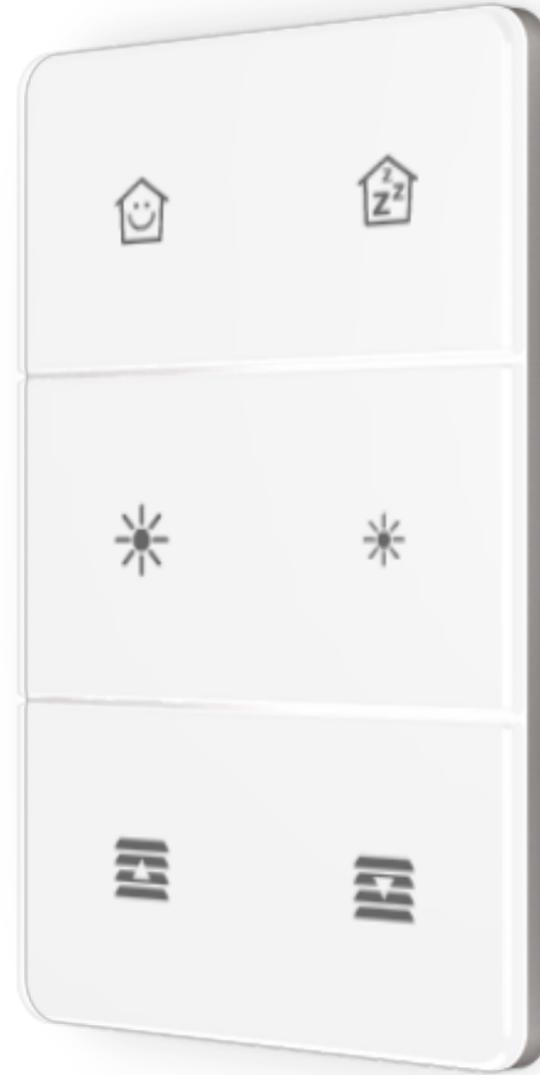
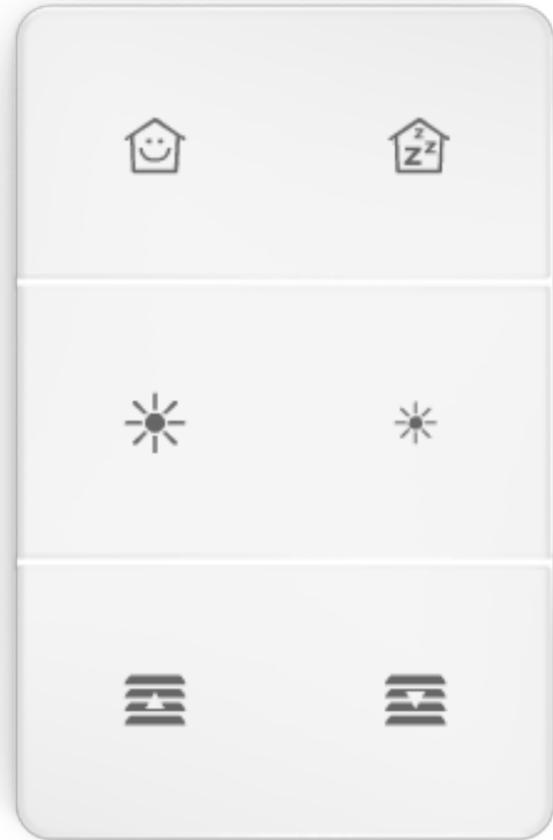

Button 1: S007	Button 4: S009
Button 2: A004	Button 5: A006
Button 3: D002	Button 6: D003



PO Number: 160527	Creation Date: May 27, 2016	Company Name: Lightmoves
12NC: Received after purchase order	Part Number: PABPA-WA-L	Project Name: Browns Road
Style: NA	Type: Button	Button Colour: White
Rim Colour: Aluminium	No. of Panels: 1	Panel Name: 01 Entry

[Download this PDF](#)

Created by: Simon L., eMail:simon.lakey@lightmoves.com.au

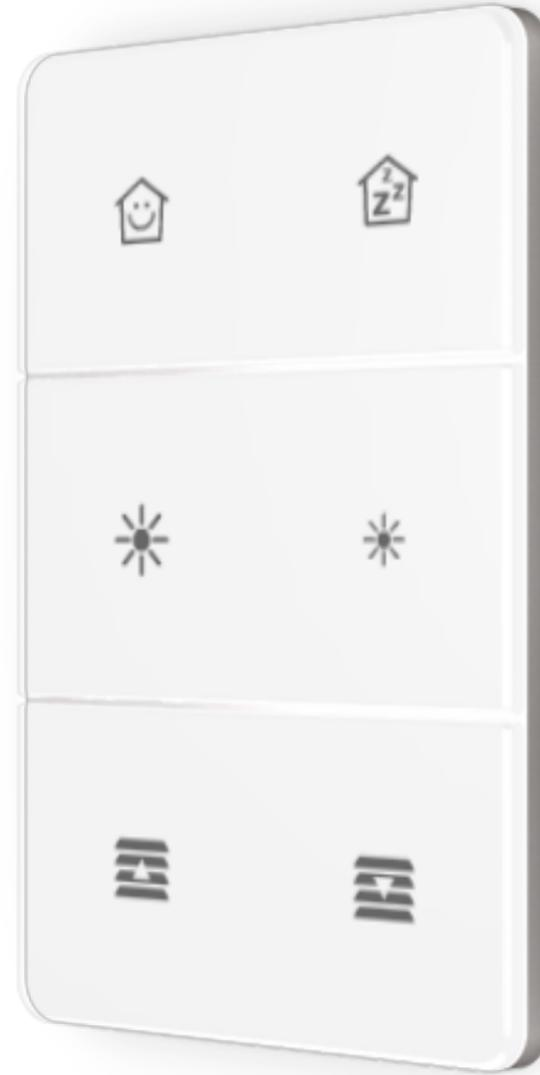
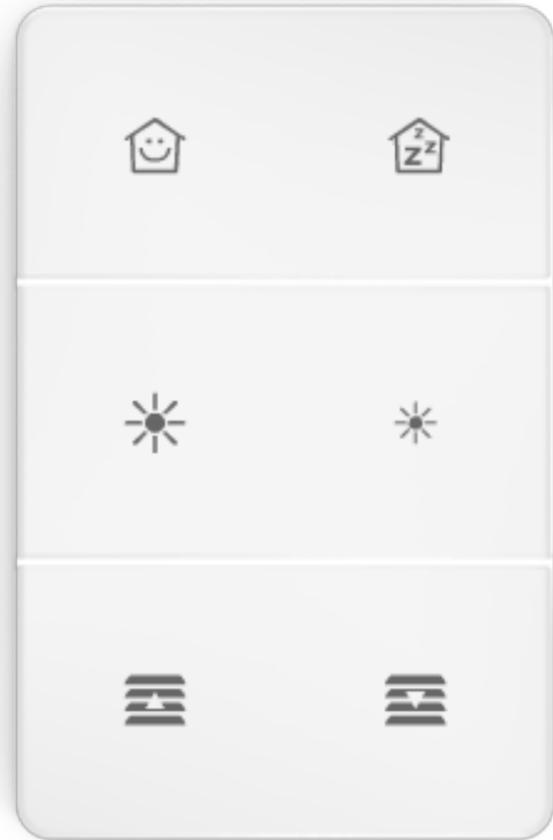

Button 1: S007	Button 4: S009
Button 2: A004	Button 5: A006
Button 3: D002	Button 6: D003



PO Number: 160527	Creation Date: May 27, 2016	Company Name: Lightmoves
12NC: Received after purchase order	Part Number: PABSA-WX-L	Project Name: Browns Road
Style: NA	Type: Button	Button Colour: White
Rim Colour: Aluminium	No. of Panels: 1	Panel Name: 01 Entry

[Download this PDF](#)

Created by: Simon L., eMail:simon.lakey@lightmoves.com.au

NOTE: Typically the Brown Pair of the DyNet Cable is not used, and left unterminated. In the case of the Antumbra Panels, the Brown Pair must be tied to ground with the Shield Wire as illustrated below:

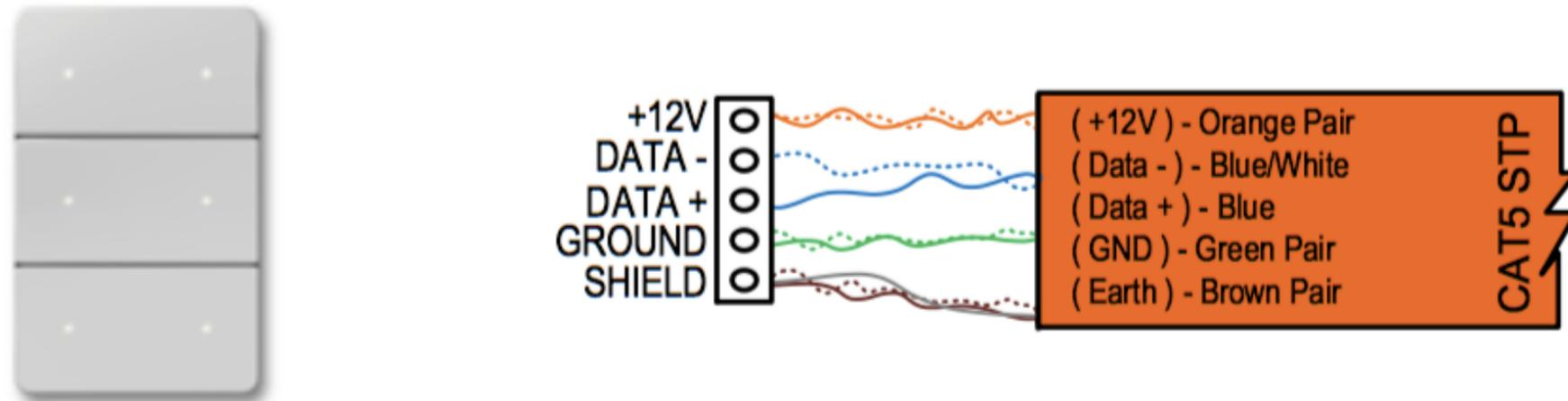



Antumbra

Installation Guide

Version 3.0

PHILIPS
dynalite 

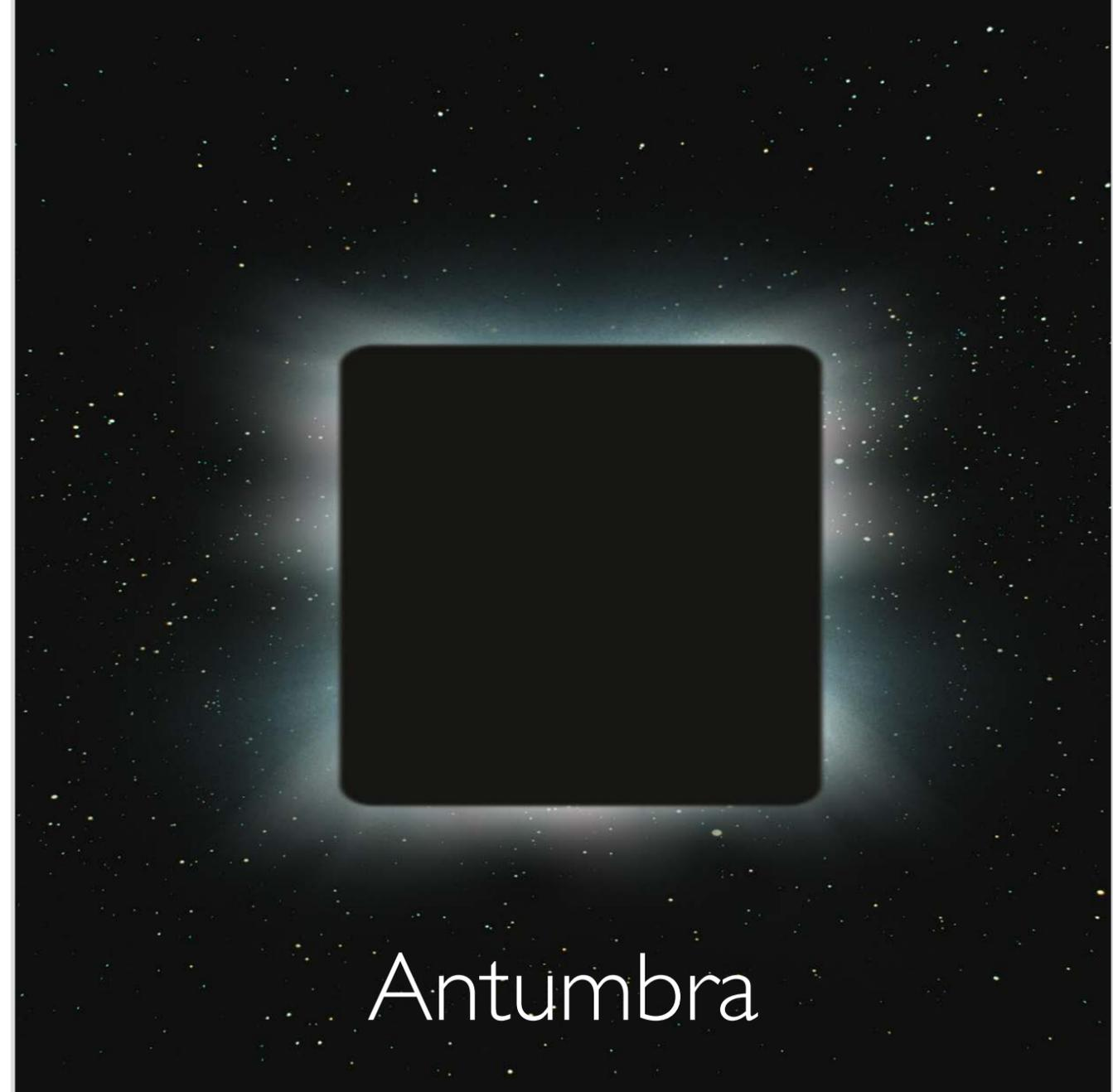

Antumbra

Next Generation User Interface for the powerful Dynalite Network

User Guide

Version 3.0

PHILIPS
dynalite 

Product Update



Revolution Series DR2P

Re-engineered button assembly & switch cap

Note:

Button cap height

Stainless steel cover bezel

Major updates:

Three-column - obsolete

OLED option - obsolete

IR option - obsolete



OLED option



Three-column



DUS804C



DUS360CR

Product Update



Multifunction Sensor DUS360CR

Dynalite **U**niversal **S**ensor
360° Ceiling **R**ecessed

Note:

IR only supports Philips RC5 codes

Insulating cover -

not compatible with surface mounting cup

Product Update

Time Clocks

DTC601



DDTCE001



DTCE601



Network Ethernet Gateway EnvisionGateway



Multipurpose ethernet gateway

Supports EnvisionTouch

Web interface

Time clock & schedule editor

Phase Out

Multipurpose Controller DDMC802



Modular design

8x Control channels

8x Output slots

Replacement model to be based on

DDMC802GL

ETA: Q1 2017

Phase Out

Multipurpose Controller DDMC802GL



Modular design

8x Control channels

4x Output slots

Replacement model to be based on

DDMC802GL

ETA: Q1 2017

Product Update

Relay Controller DDRC1220FR-GL-V2

Additional features include:

Standard channel override & indicators

2x RJ12 sockets

8x Dry contact inputs (non-isolated)

Top accessible network sign-on

Common supply terminal order



Product Update

Relay Controller DDRC810DT-GL-V2



Additional features include:

Standard channel override & indicators

2x RJ12 sockets

8x Dry contact inputs (non-isolated)

Top accessible network sign-on

Common supply terminal order

Product Update

Room Controller DDRC-GRMS

Compact dedicated controller for
room control

Features:

- 2x 16A Heavy duty power outputs
- 9x 6A Lighting control relays
- 1x 6A Directional blind motor control
- 18x Dry contact inputs (isolated)
- 2x RJ12 sockets
- Top Accessible network sign-on
- Common supply terminal order



Product Highlight

Room Controller DDRC-GRMSPLUS

Compact dedicated controller for
room control solutions

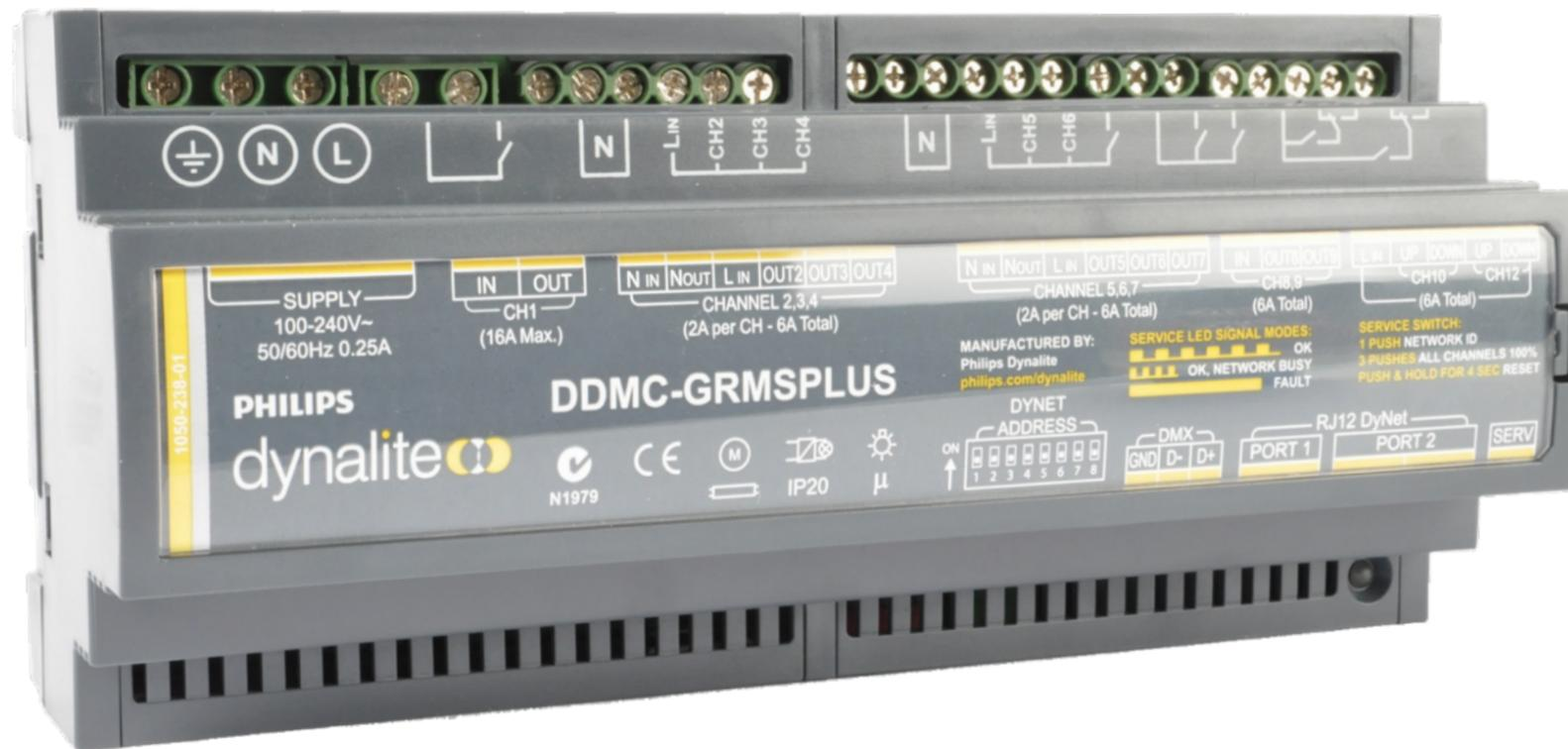

Features:

- 1x 16A Heavy duty power relay
- 3x 6A Power relays
- 5x 6A TE dimming
- 2x 6A Directional blind motor control
- 16x Ch DMX control

Old Design

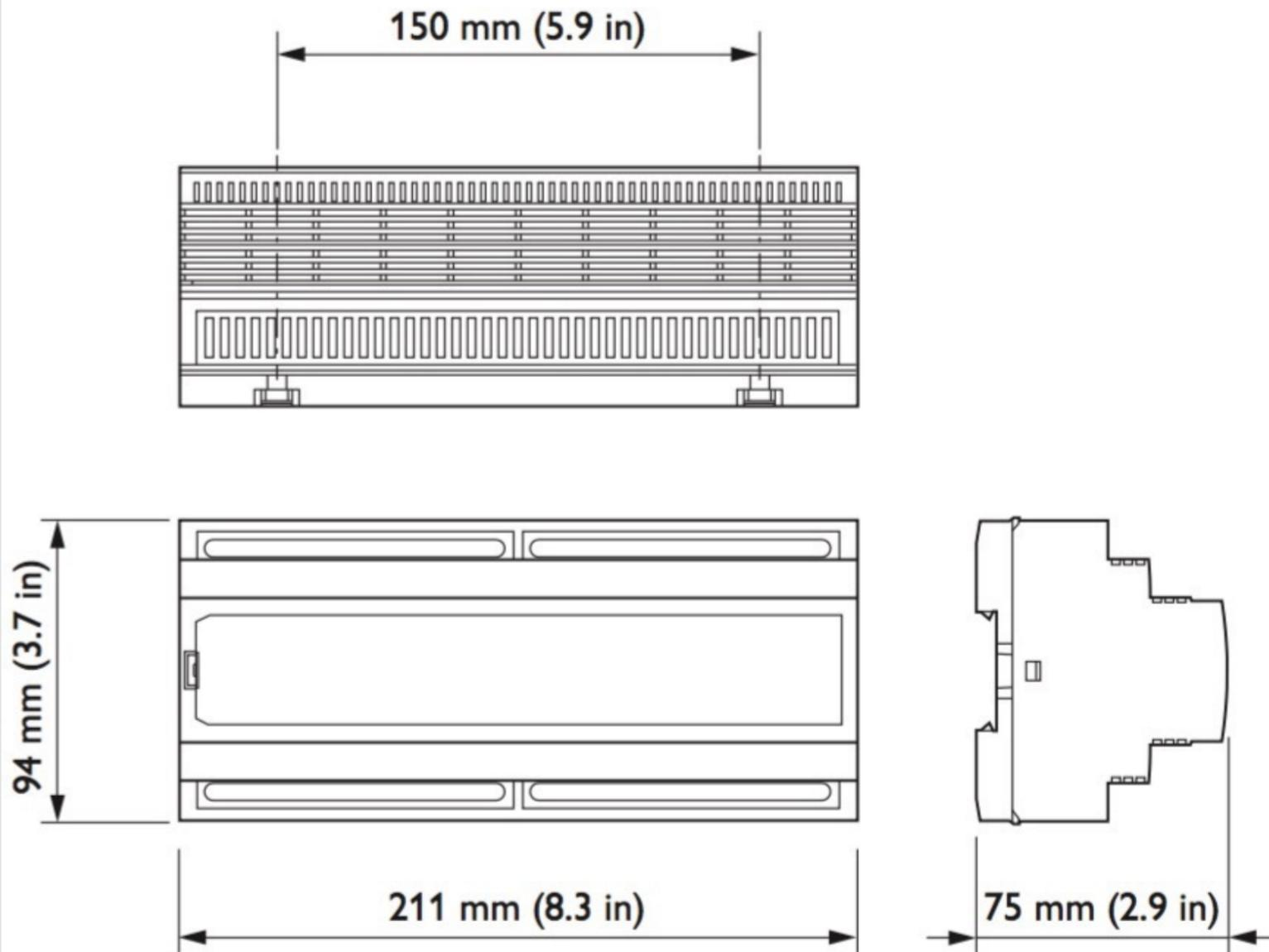

New Design

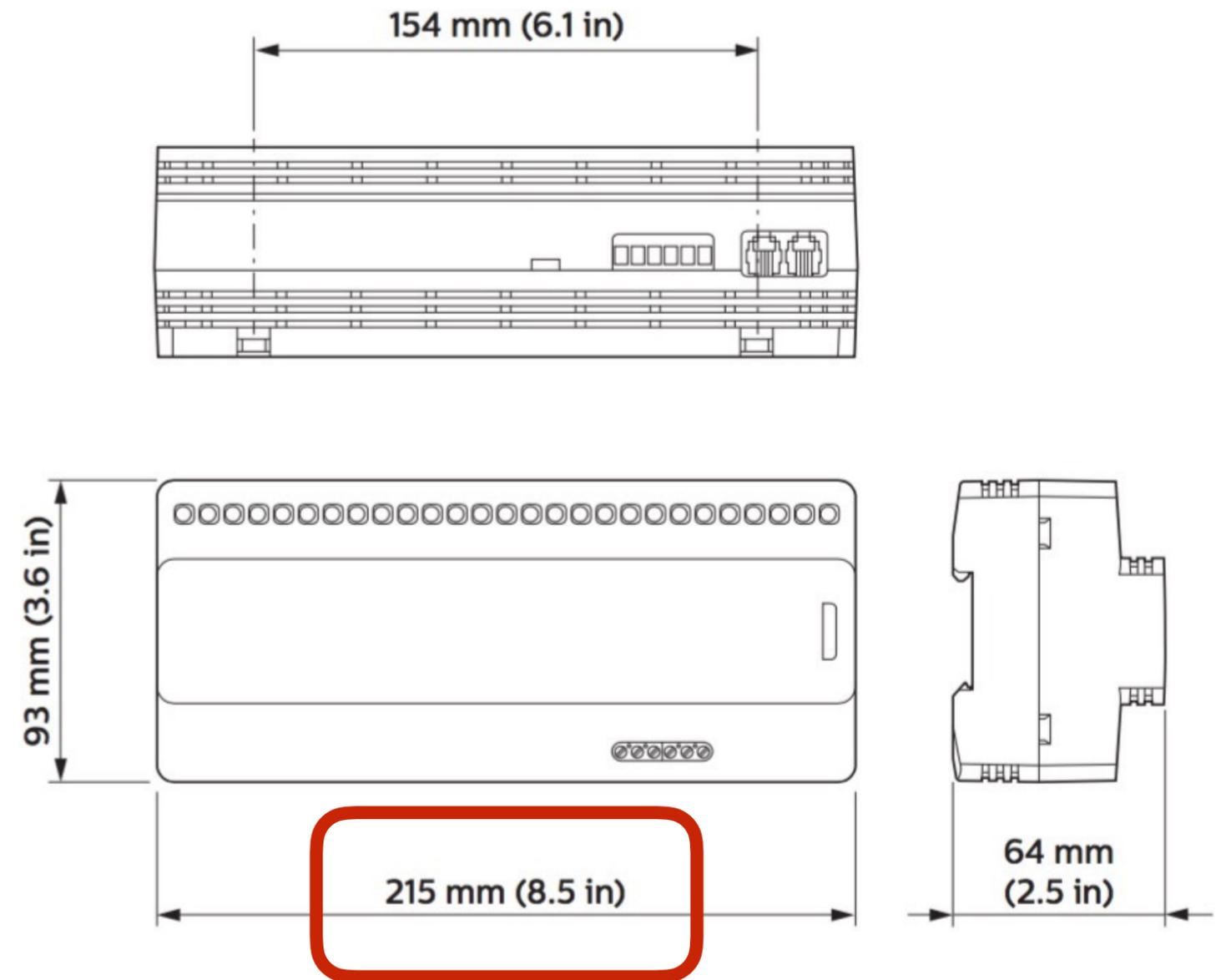

Product Update

Dry Contact Interface



DPMI940

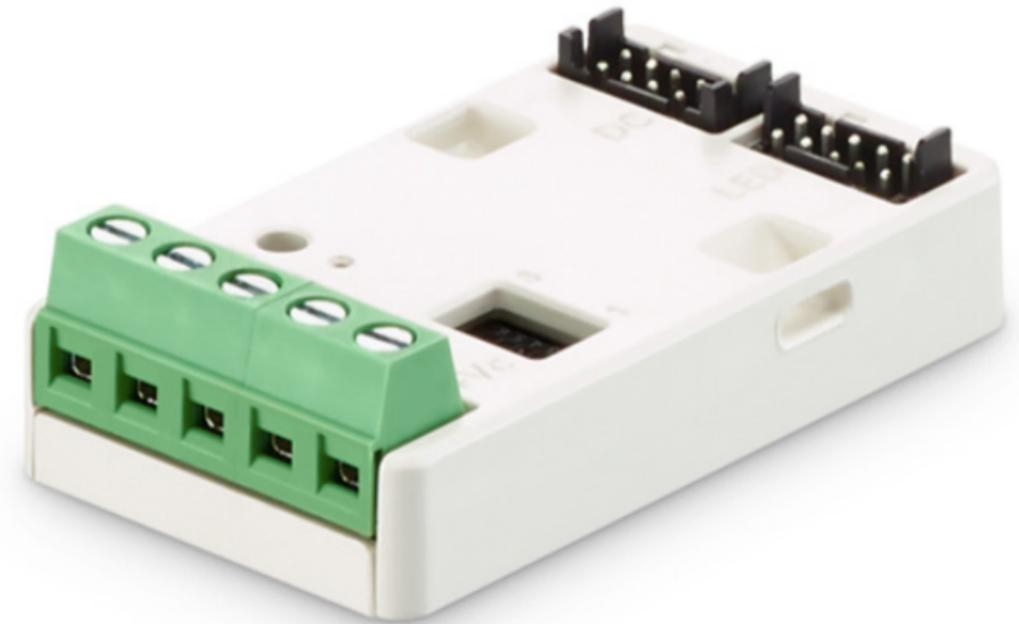

DLLI8180

Product Update

Dry Contact Interface DLLI8I8O

Dynalite **L**ow **L**evel Interface **8** Inputs **8** Outputs

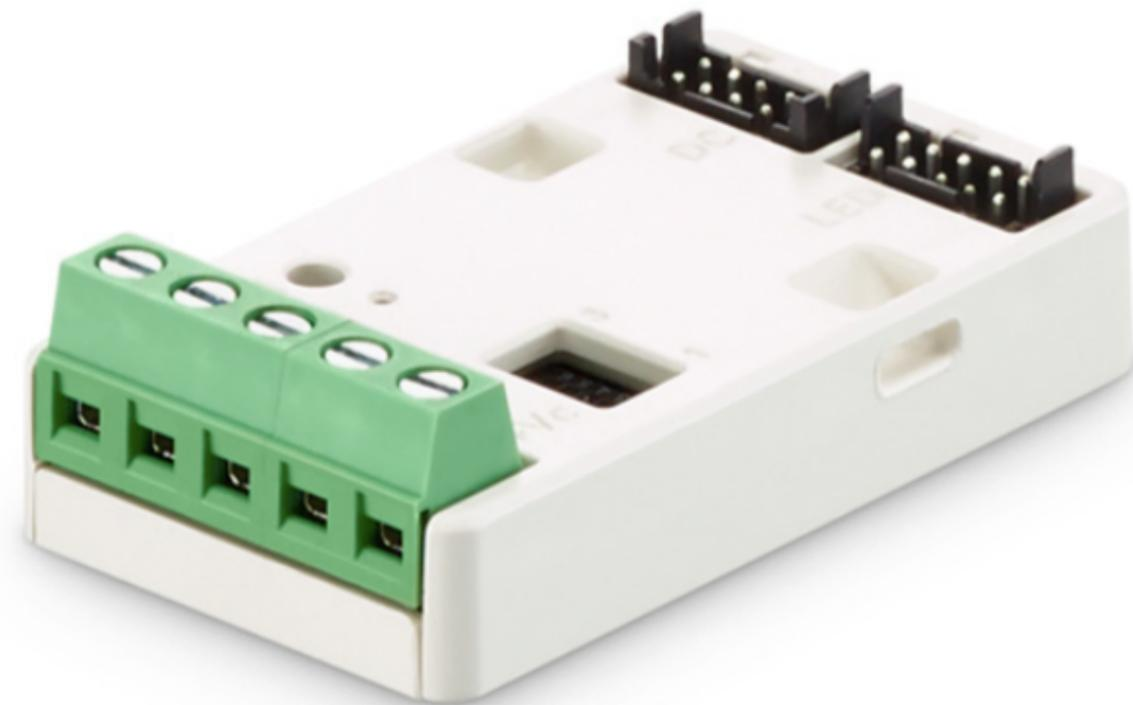

Compact size

8x Dry contact inputs

8x Indicator outputs

Allows up to 20m cable runs

Note:

Installation with Optex LX-402

Mobile Applications

Intelligent system control through a smartphone or tablet interface



PHILIPS

dynalite 
dimension

PHILIPS

dynalite 

Dimension
Master Dealer

connected living 

◀CONNECTING YOUR WORLD▶

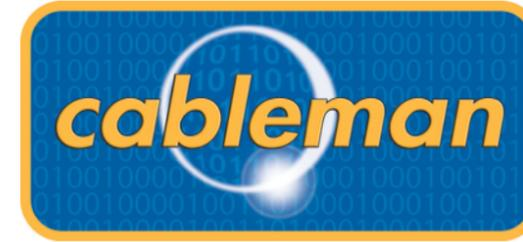

ATRICSelectrical



Clever Living

Custom Home Theatre

PHILIPS
dynamalite 

**Certified
Installer**



 **KeyNoteControls**
Custom Control Systems Software Specialists

AUDIO VISUAL
Klapp

 **recluse.av**
creating enthusiasts

Urban
INTELLIGENCE
technology made simple



[Documentation](#)

[Downloads](#)

[Training](#)

[Lightmoves Dealer Portal](#)

Iconic Projects

Lightmoves is sought after for some of Australia's most iconic projects

[See more Projects](#)

Photography by Sandra Davis



Lightmoves Dealer Portal

You need to login to view this content. Please [Login](#). Not a Member? [Join Us](#)

Username

Password

Remember Me

Login

[Forgot Password?](#)

[Join Us](#)

[Edit your profile here.](#)



Simon Lakey

Lighting Control Solutions

Mobile: 0418 568 393

Office: 03 9701 2500

Email: simon.lakey@lightmoves.com.au

138-146 Browns Road

Noble Park, VIC 3174 Australia

www.lightmoves.com.au